



ONE TEAM,
VISION



HIDRAMAR GROUP OVERVIEW

- Hidramar Group is a family-owned group of shipyards in the Canary Islands.
- Based on the three main Ports of this European archipelago, we deliver certainties on the crossroads that connect four continents.
- Hidramar Group offers shipyard technical support and fabrication services to the Oil & Gas industry and naval sector since 1989.
- In-house resourcing strategy differentiates the Group, allowing us to ensure safe and quality delivery in all our projects.
- Continuous reinvestment in unique capabilities, positions the Group as a reference in the West African Region.



Certified Company:
Hidramar, S.L.



Certified Company:
Tenerife Shipyards, S.A.



Q1-3177
Certified Company:
Hidramar, S.L.



7-1-1364
5CT - 2182
Certified Company:
Hidramar, S.L.



Certified Company:
Hidramar, S.L.

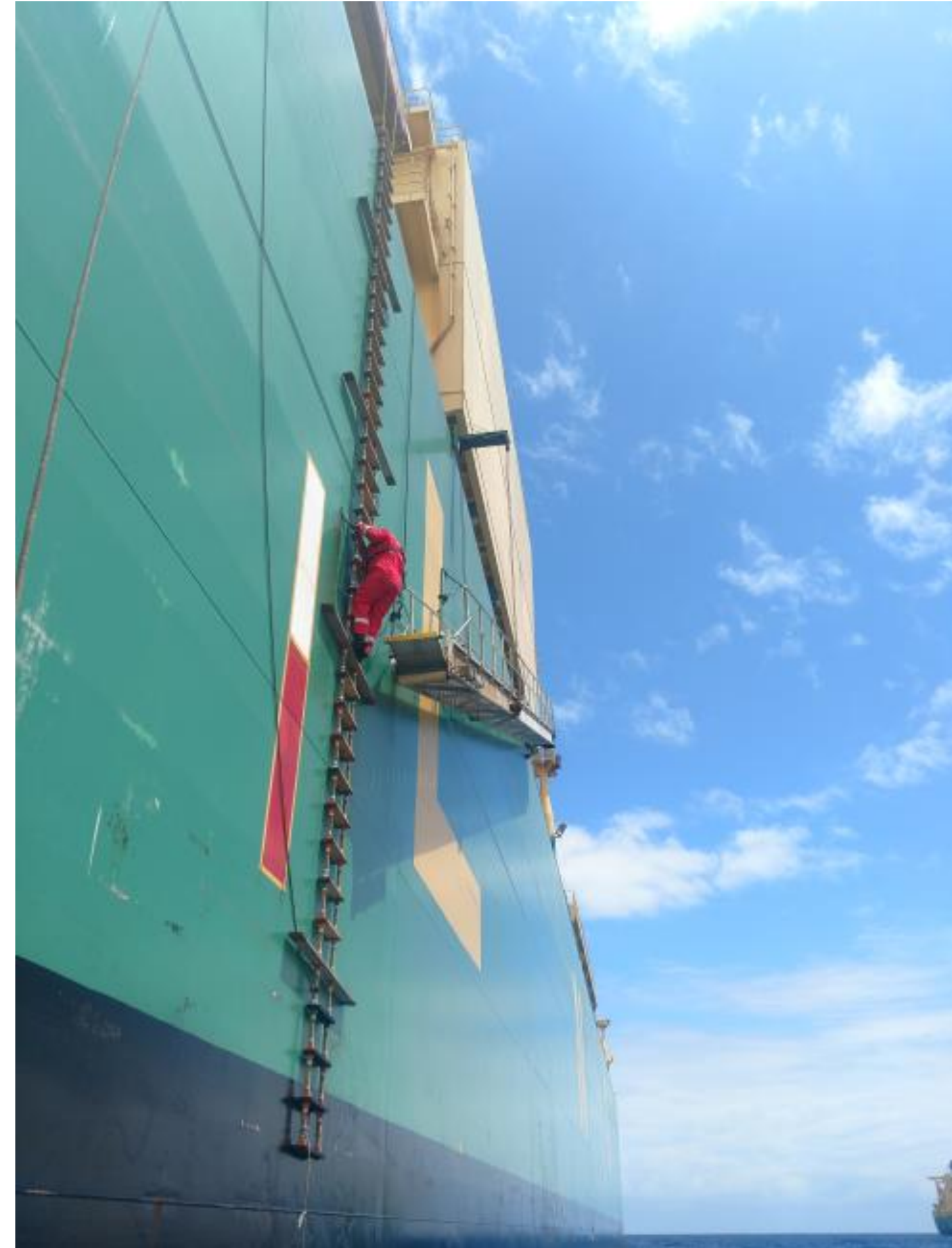

A FORTUNATE LOCATION WITHIN THE ATLANTIC

COUNRIES	CITIES	DISTANCE	TRANSIT TIME
Brasil	Recife	3229 NM	13,5 days
France	Marseille	1643 NM	6,8 days
Norway	Bergen	2700 NM	11,3 days
Portugal	Lisbon	956 NM	4 days
Senegal	Dakar	862 NM	3,7 days
Spain	Cádiz	850 NM	3,5 days
Spain	Avilés	1510 NM	5 days
USA	New York	3496 NM	14,6 days
UK	Cardiff	1883 NM	7,9 days



Strategically placed within the main Energy fields in the Atlantic. We deliver certainties as Europe last port in the Region. The connectivity with mayor freights lines and linked through 5 different international airports within the archipelago. Makes the Canaries as the right location for project executions.



HIDRAMAR GROUP HISTORY IN TIMELINE

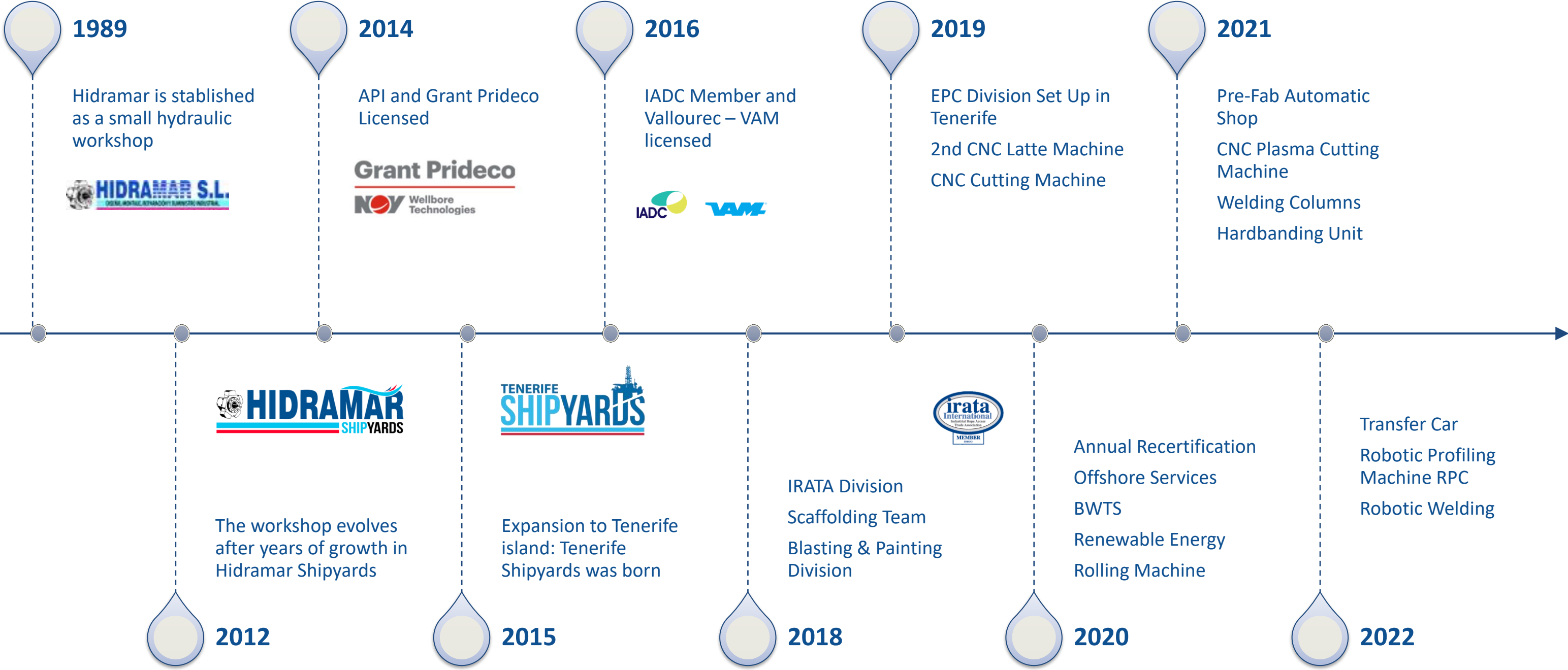

HIDRAMAR GROUP LOCATIONS

Hidramar Group holds outstanding capacities on the main ports of Canary Islands. Well placed European infrastructure and the proximity of 3 international airports allow right set up for any Project execution.

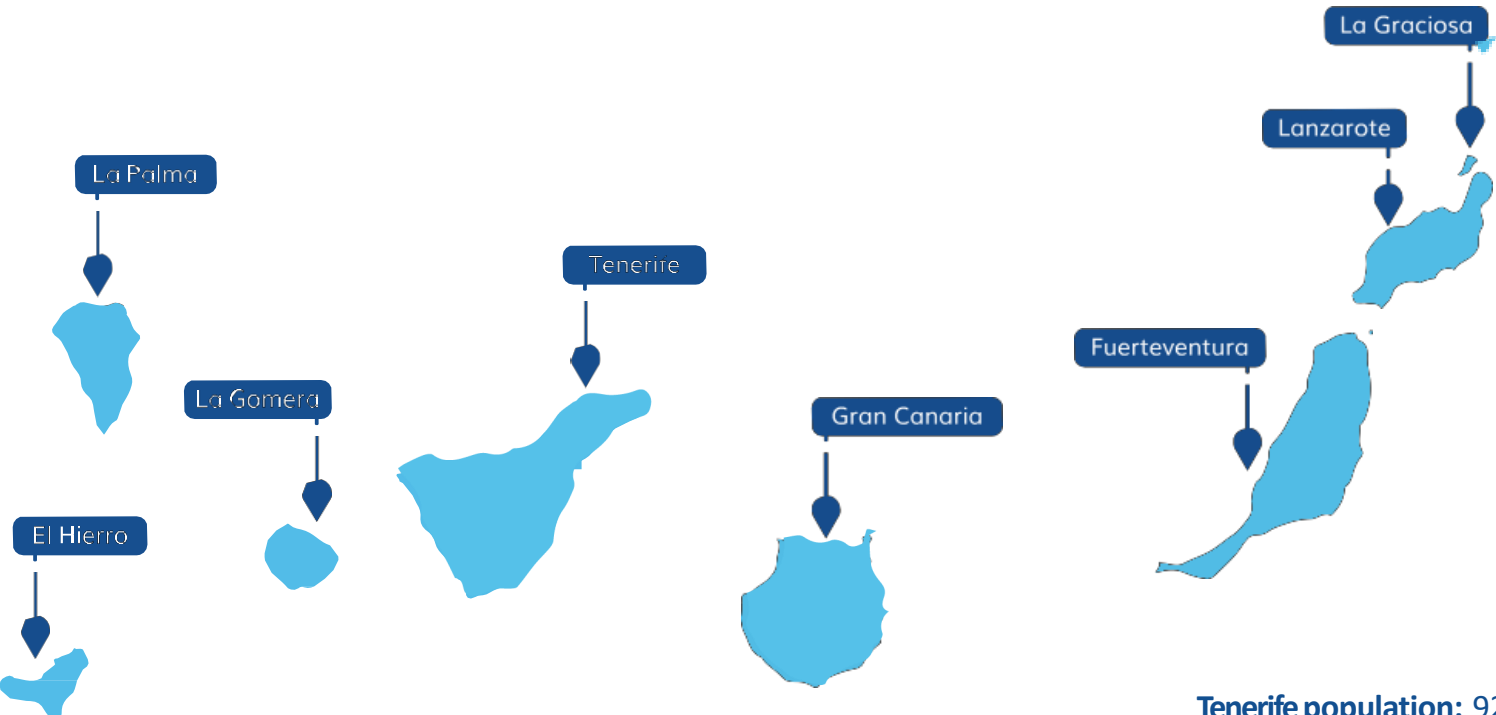
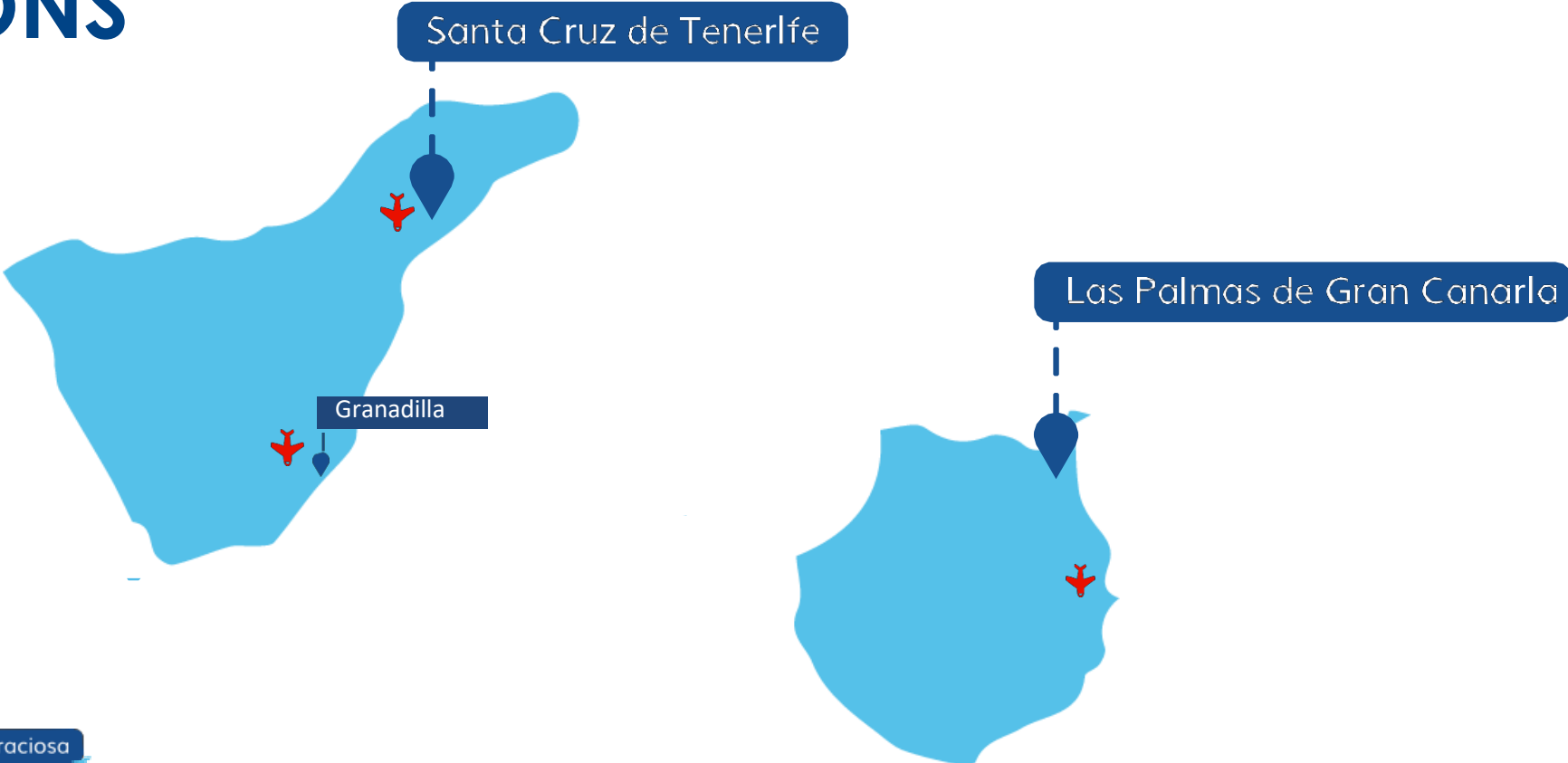

Tenerife population: 927.993

Gran Canaria population: 852.688



TENERIFE SHIPYARDS

Granadilla Port

- Quayside length 350 meters.
- Quayside Operation area 13,50 meters
- Yard Space 30.000m²
- Bollard strength 200 tons
- Waterdepth > 18 meters

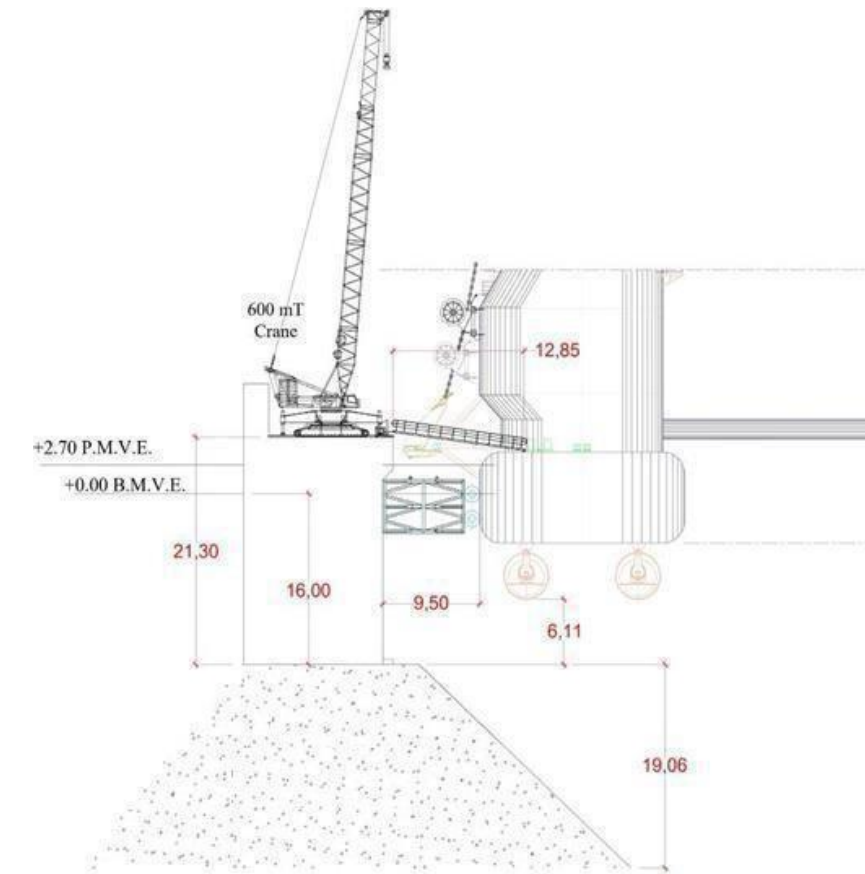

TENERIFE SHIPYARDS

Santa Cruz de Tenerife Port

- Quayside length 460 meters.
- Quayside Operation area 13,50 meters
- Yard Space 20.000 m2
- Bollard strength 150 tons
- Waterdepth > 16 meters



Tenerife Port anchorage offers sheltered waters on a volcanic seabed. With European standard facilities and services making this anchorage a convenient spot for laying for orders or afloat maintenance services.

HIDRAMAR SHIPYARDS



Zona Franca Las Palmas Port, Gran Canaria
 15.000 m2 Free Trade Zone Mechanical and Hydraulic
 Workshops OCTG and logistic Yard



Reina Sofia Pier Las Palmas Port, Gran
 Canaria 200 meter keyside (ISPS) Yard
 15.000m2 Fabrication Yards



LOGISTIC YARDS

Unique European certainties, Free trade zones for smooth customs, right bathymetry and in-house Shipyards capabilities. Position our Group as a strategic Hub for West African projects.



INHOUSE ENGINEERING INTEGRATED WITH OUR FABRICATION SHOPS TO DELIVER ACCURACY AND TIME EFFICIENCY TO OUR CLIENTS DEMANDS:

- Modelling after 3D Scanning.
- Vessel diagrams and drawings for classification society for approval.
- Hydraulic, electrical and structural analysis.
- Detailed drawings and documents for prefabrication and installation phase.
- Exhaustive prefabrication and installation plan will be projected to reduce asset downtime.

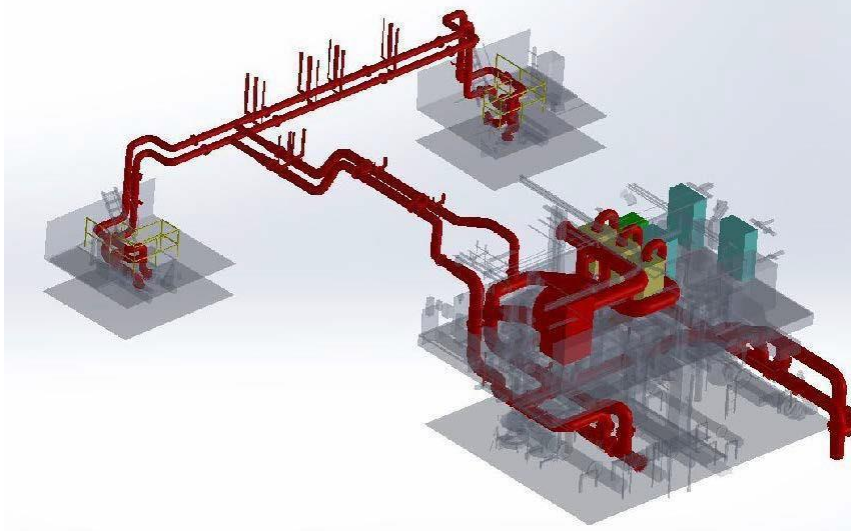
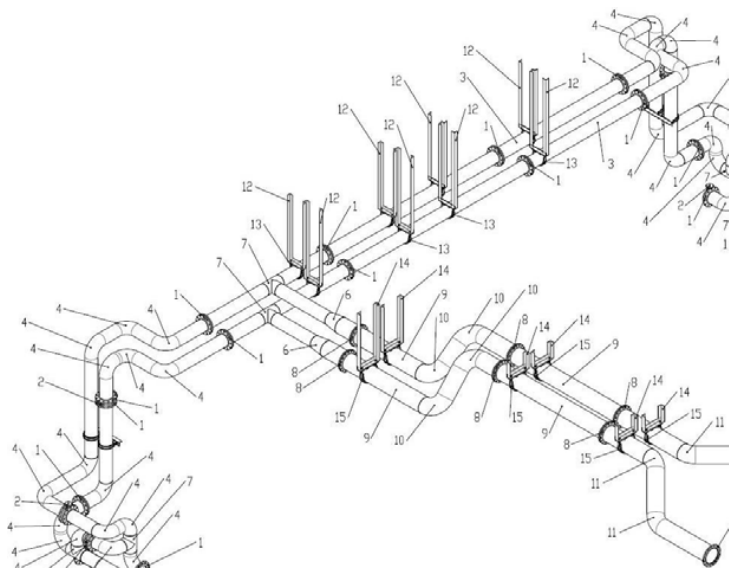
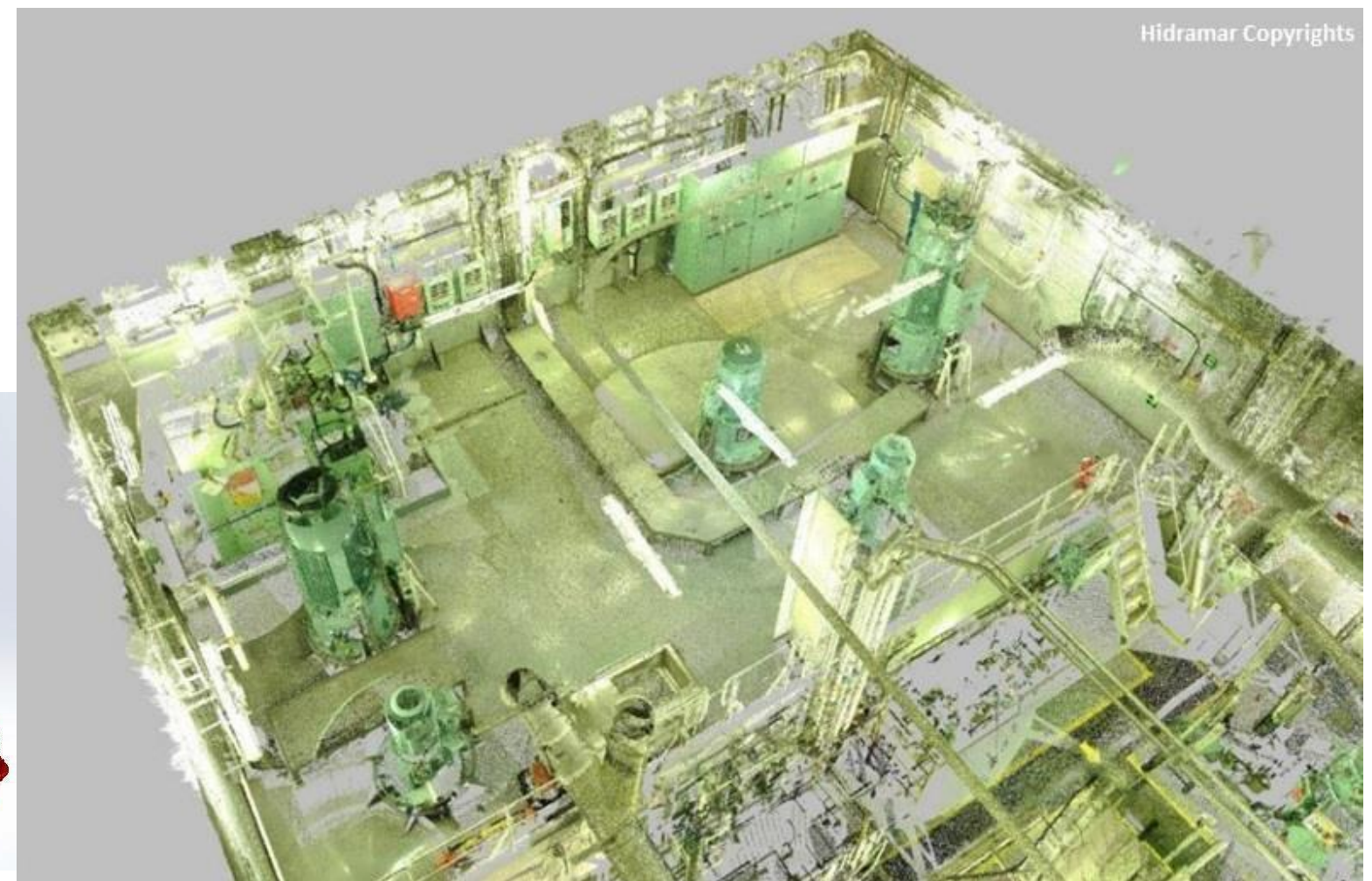
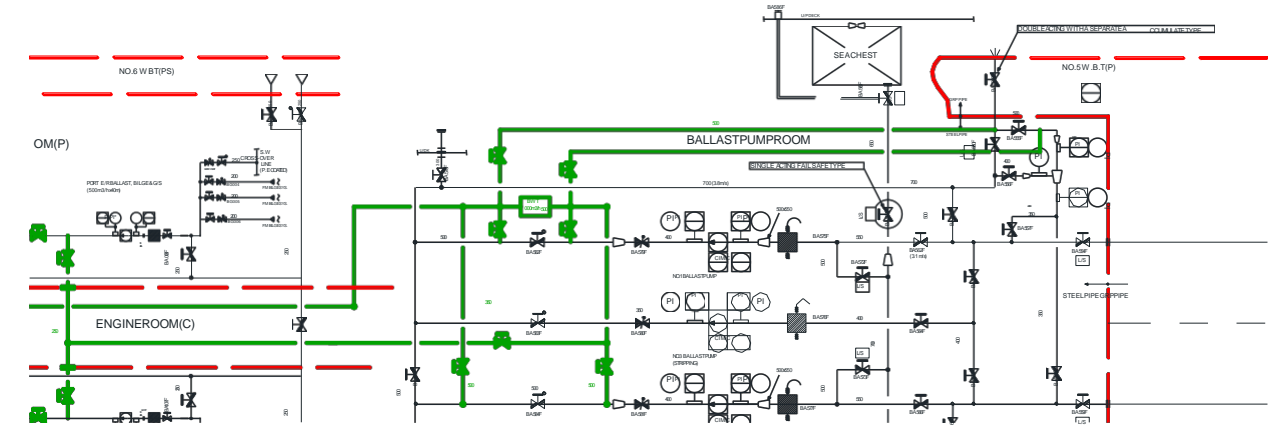

CAPABILITIES

The flexibility and knowledge of our people allow us to develop welding procedures according to some of the most stringent codes. Used to working with AWS, ISO and ASME codes for structural welding operations, DNV , API and ASME codes for pressure piping and tubing welding operations, our welding experts prove their agility every day to meet our clients' technical requirements.

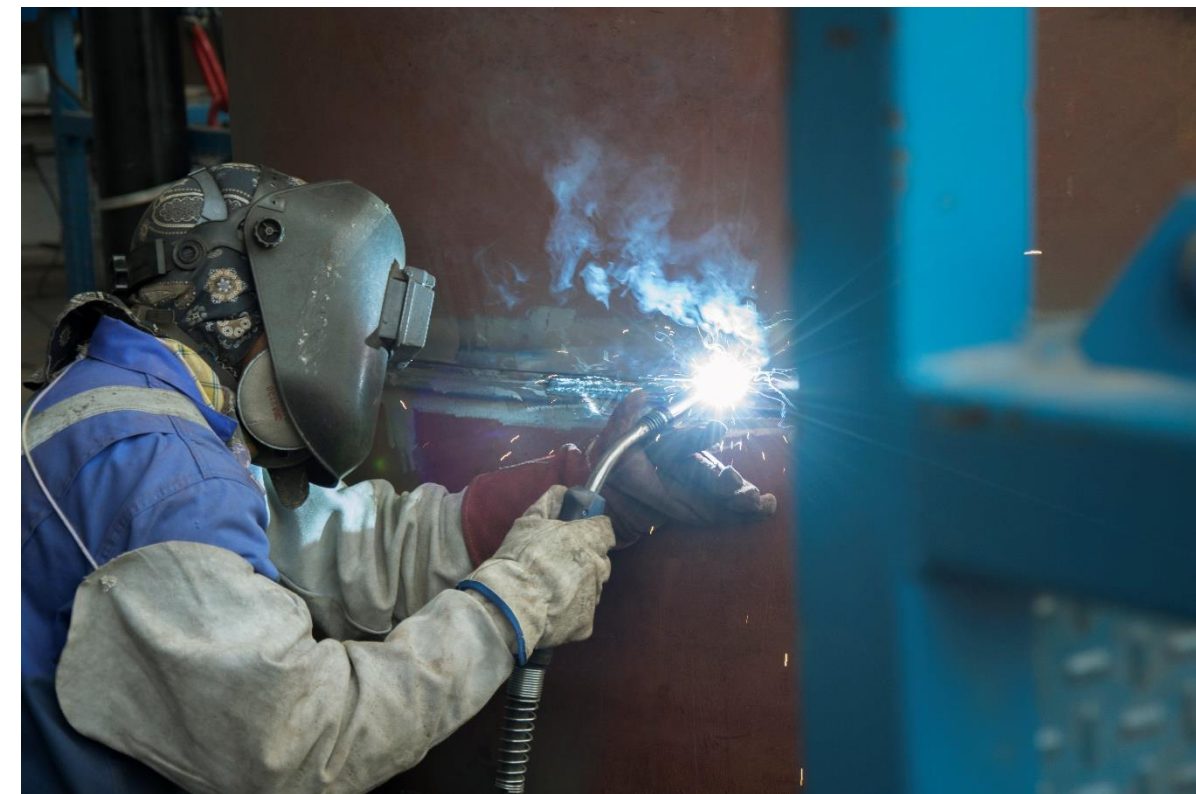

Certified Company:
Hidramar, S.L.



Certified Company:
Tenerife Shipyards, S.A.



Q1-3177
Certified Company:
Hidramar, S.L.



7-1-1364
5CT - 2182
Certified Company:
Hidramar, S.L.



Certified Company:
Hidramar, S.L.

OFFSHORE SERVICES

In-house Offshore certified workforce with strong expertise in several disciplines, supported on containerized workshops solutions are able to deliver same certainties we deliver within our yards without matter where the assets are.

We count with a first-class workforce ready to support onboard scopes to reduce downtimes and seize the transit time to your next contract. Among others, we can provide:

- 3D Scanning
- Pipeworks and foundations
- Electrical scopes
- Preinstallations and Precommissioning

Our crew members are offshore certified (OGUK medical-BOSIET) with seaman book, able to board vessels globally.



MODULAR HOT WORKS HABITATS

Working in collaboration with Safe House Habitats, we can deploy these systems and perform hot works while the assets operate. With out matter of asset location, our containerized solutions bring the demanded certainties to safely deliver on-time any given repair.



PIPE FABRICATION

Our lean manufacturing processes and in-house personnel are experienced in the demanding procedures of the Oil and Gas industry working closely with the engineering team to ensure we deliver the best pipe and steel works option in the Region.

At our shipyards, we have special alloy workshops that give us the capabilities to fabricate different materials such as high-alloy steel grades, stainless, carbon steel, inox duplex and super duplex steel.

To carry out factory acceptance tests especially the pressure testing in safe conditions, a dedicated pit has been implemented with a test bench enabling pressure testing up to 2 500 bars / 36 000 PSI.

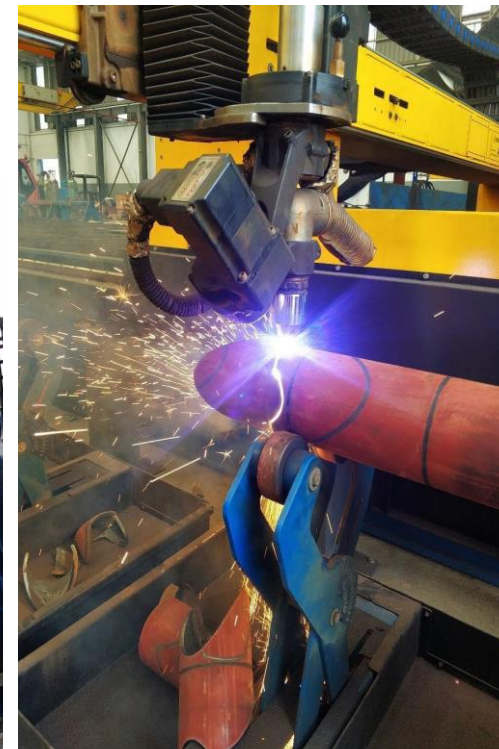

QUALITY MANAGEMENT SYSTEM

Hidramar Group operates a comprehensive integrated QHSE management system. We are constantly seeking to improve and to ensure that our organizational structure keeps up with other leading international companies' standards.



HYDRAULIC SERVICES

The name of our group comes from our background as a hydraulic workshop.

After 3 decades we have grown relying on that same workforce that positioned us as the reference on Hydraulics services all over the West African Region, delivering since our beginnings reliable services to the Fishing fleet and now at days also to the Oil and Gas and Mining industries.



MECHANICAL SERVICES

Well equipped workshops and our open doors strategy to OEM's have established a long expertise within our talented personel.



CNC MACHINING SERVICES

HIDRAMAR SHIPYARDS
NOV GP LICENSEE

We aim to be a pioneering Holding Company, challenging ourselves to always have an innovative and technical mindset; continually testing new ways of doing our work, learning from it, and improving it.

At the moment, we are the only one in West Africa with two licenses to manufacture & repair API & NOV GP drilling connections Under the following specifications:

*API Specification Q1, API Specification 7-1,
API Specification 5CT Casing and Tubing.*

Licensed premium connections:

DPR HP™

XT™

TT™ uGPDS™ 40 and smaller

uGPDS™

GPDS™

Grant Prideco EIS™

Grant Prideco Express™ (VX™)



TLA 17-1620



Q1-3177



7-1-1364

5CT-1364



Scaffolding Services

Having own means is the key to deliver a prompt and safe access, while ensuring to bring the cost efficiency to our Clients.

[SCAFFOLD FOR ROV DOORS PIN REMOVAL](#)
[HIDRAMAR GROUP - YouTube](#)



ROPE ACCESS GWO CERTIFIED



Works on heights certification at the international level IRATA under the member number 5080 / O.

Rope access technicians have strong experience on safely executing, works in areas of apparent difficult access, following the strictest safety precautions. Our technicians can perform jobslike:

- 6G approved welding (GTAW, SMAW, FCAW GMAW).
- Hydraulic and Pneumatic mechanics.
- Non Destructive Testing (NDT).
- Industrial cleaning.
- Labeling and painting.
- Roofs and metal facades..
- Crane maintenance.
- Inspection and Repair of Blades.
- Installation and change of phenolic.
- Lifelines and protective nets installations.
- Installation of fireplaces and heat-insulation.

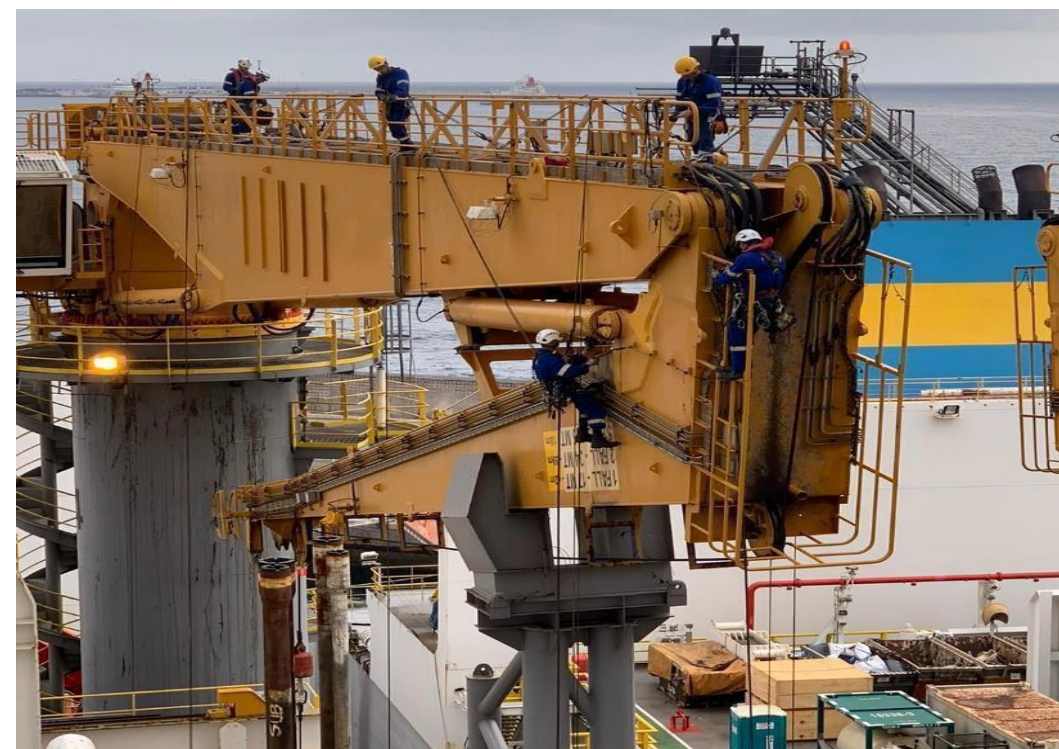
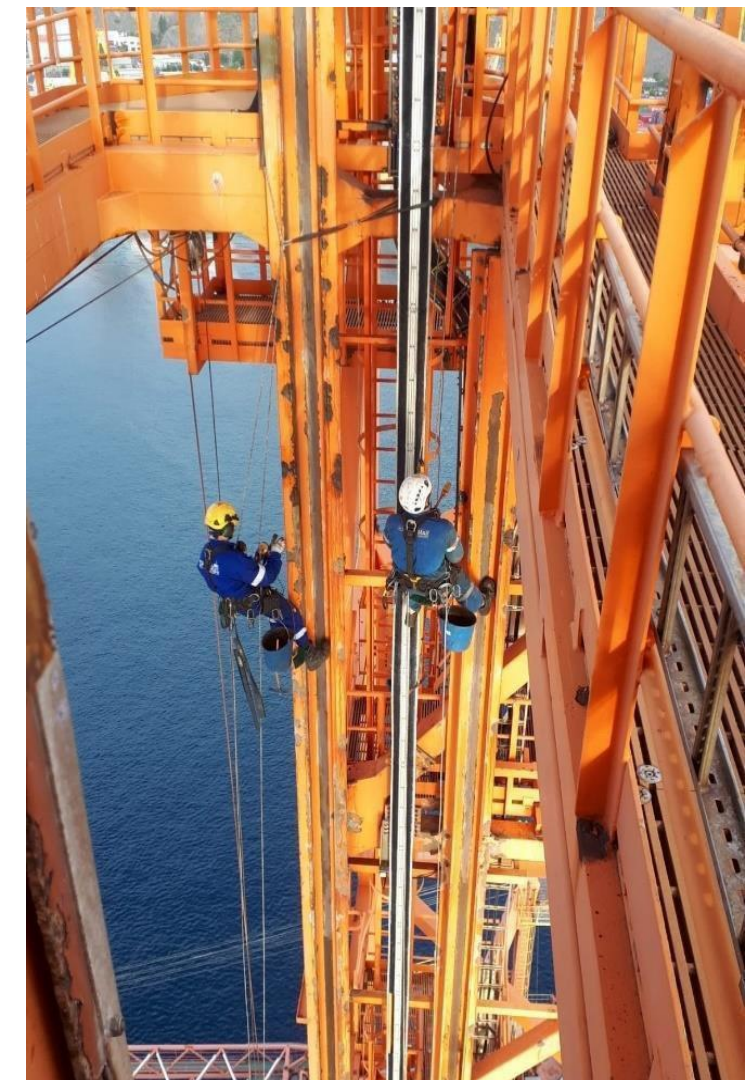

COATING AND PAINTING

Environmentally friendly solutions while ensuring cost efficiency for coating services. To deliver without limitations on the highest standards.

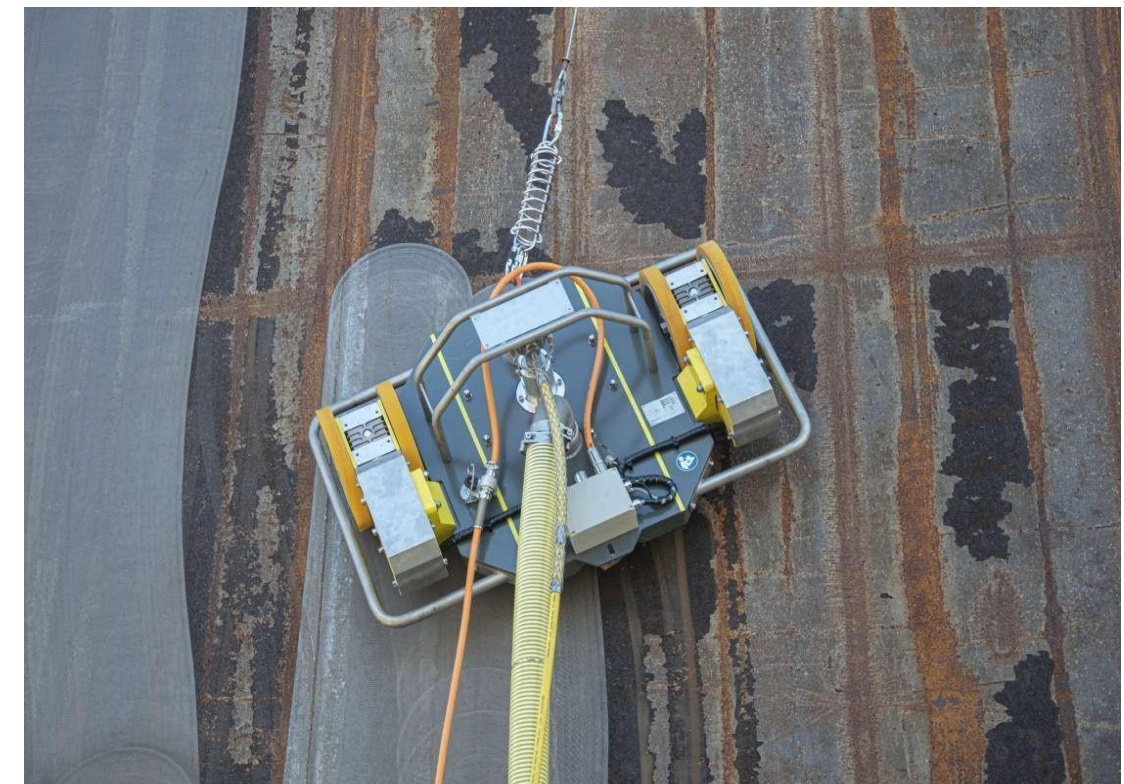
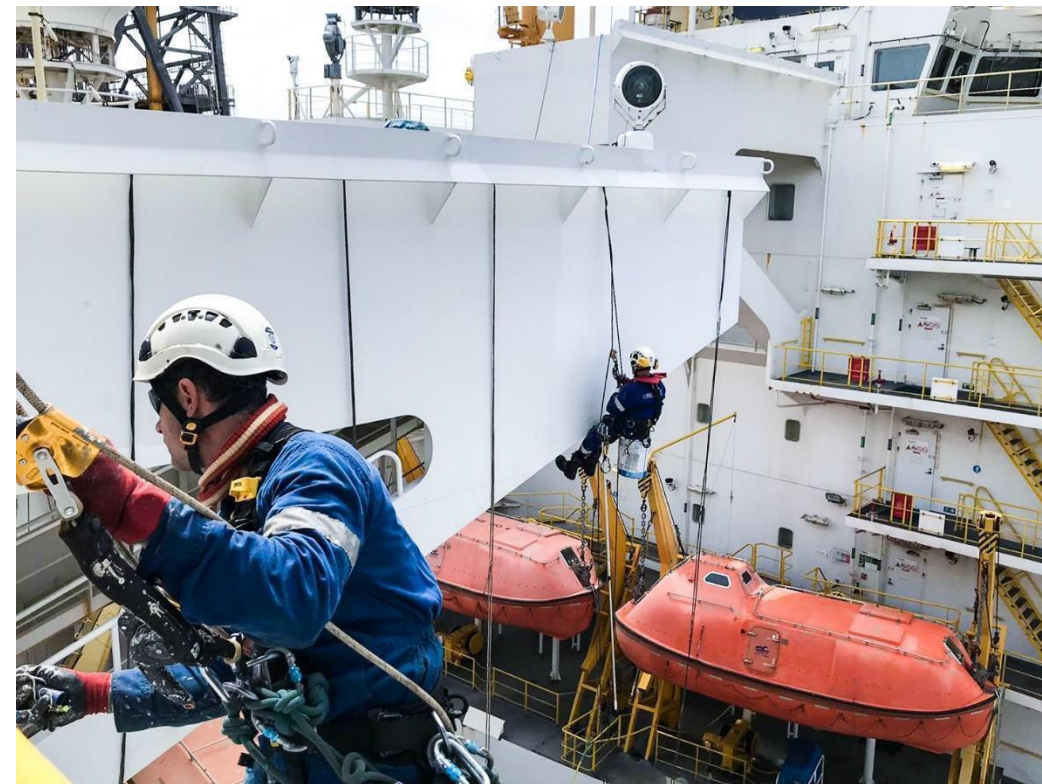

WE ADHERE TO THE INTERNATIONAL STANDARDS



Certified Company:
Hidramar, S.L.



Certified Company:
Tenerife Shipyards, S.A.



Q1-3177
Certified Company:
Hidramar, S.L.



7-1-1364
5CT - 2182
Certified Company:
Hidramar, S.L.



Certified Company:
Hidramar, S.L.



Works safely executed

LNG – MT Nolde

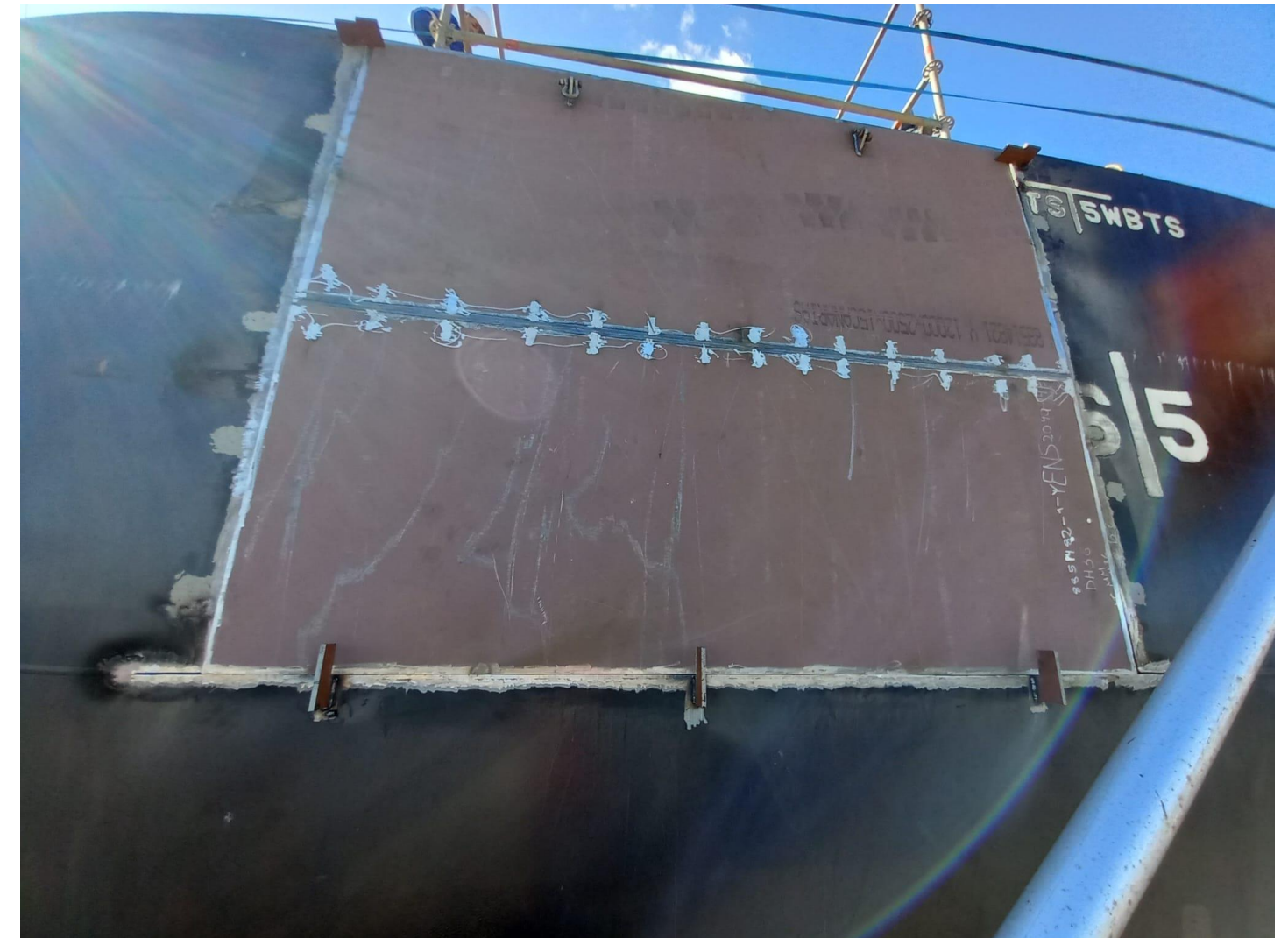
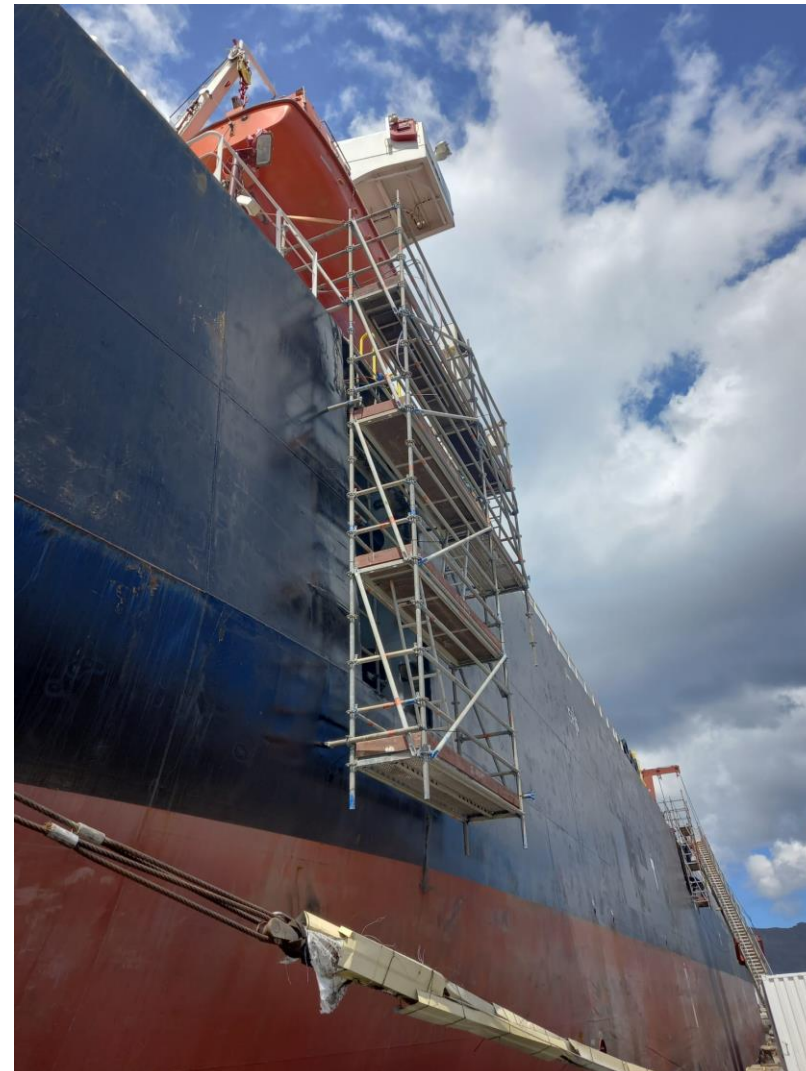
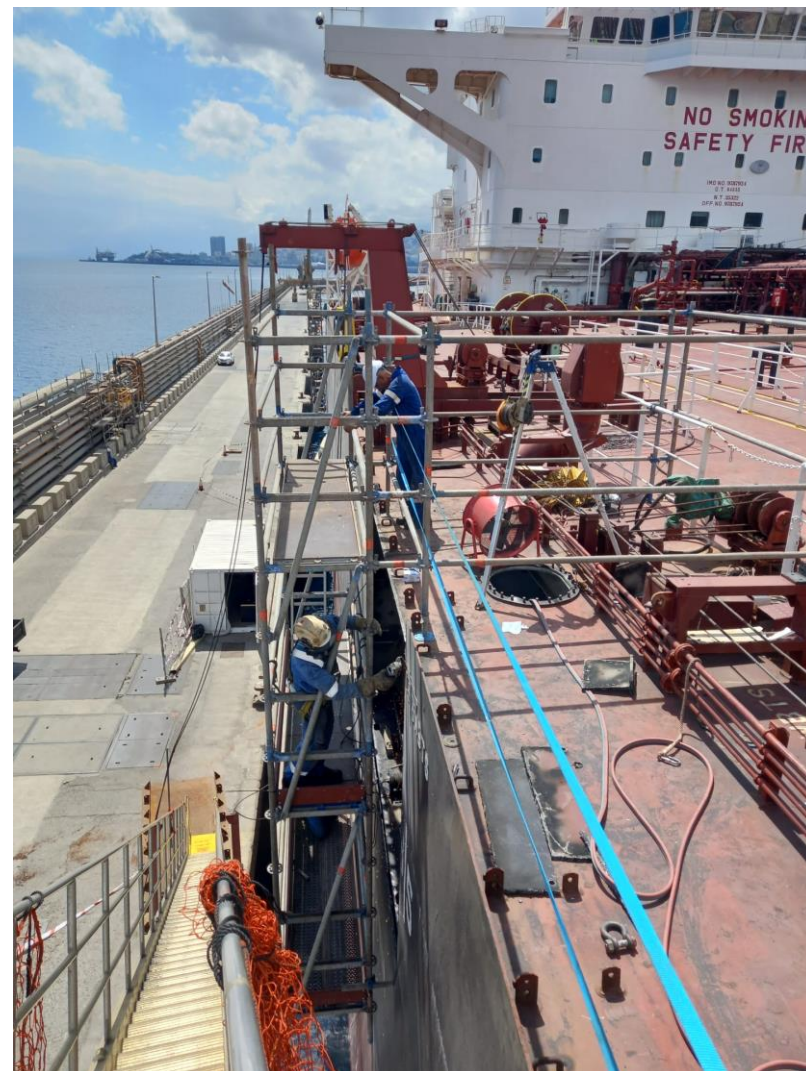

Works safely executed

Torm Atlantic

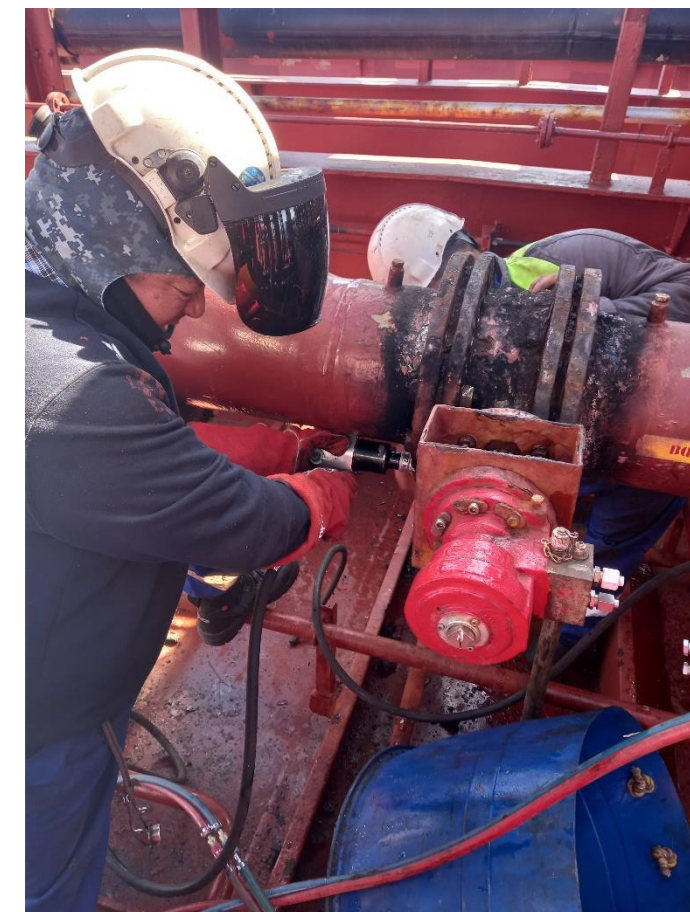
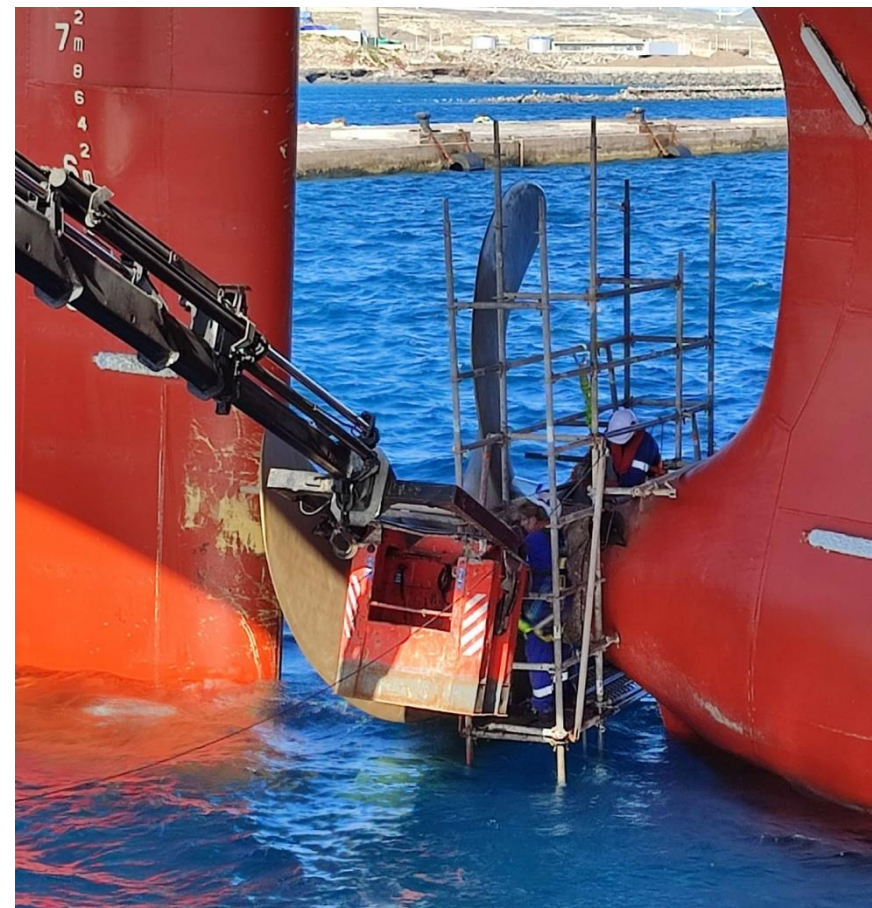

Works safely executed

LNG – Torm Hilde

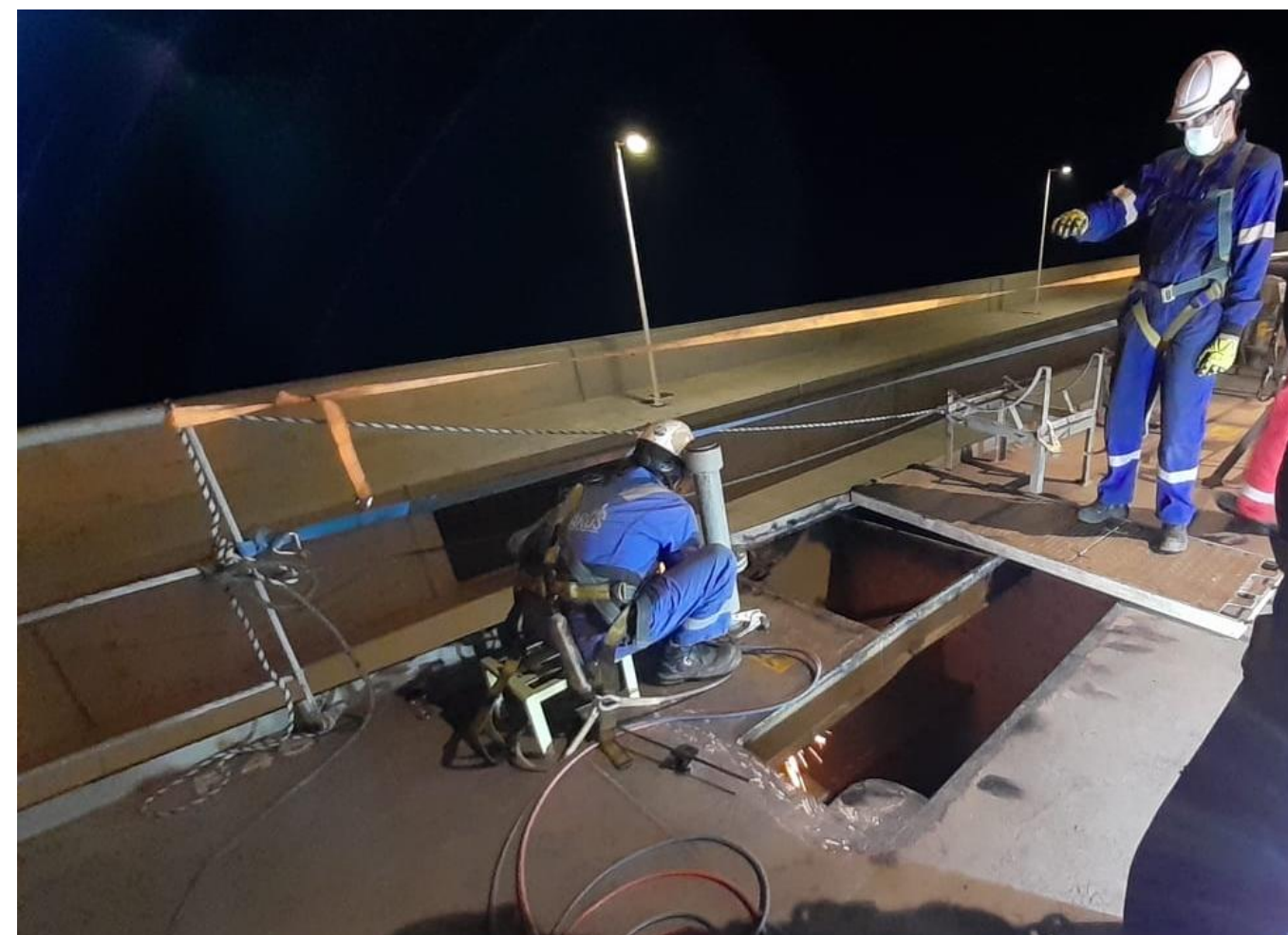

Works safely executed

Torm Amalie



Thank you
very much!



ONE TEAM,
VISION

